

Agilent E5072A ENA Series Network Analyzer

30 kHz to 4.5/8.5 GHz

Data Sheet



Agilent Technologies

Options

This document provides technical specifications for the E5072A ENA network analyzer.

E5072A-245	2-port with configurable test set, 30 kHz to 4.5 GHz
E5072A-285	2-port with configurable test set, 30 kHz to 8.5 GHz

Calibration kits and ECal modules

This E5072A data sheet provides technical specifications for the following calibration kits and ECal modules. For models not listed in this data sheet, please download the free Uncertainty Calculator from www.agilent.com/find/na_calculator to generate the curves for your calibration kit.

85032F	Calibration kit
85033E	Calibration kit
85092C	Electronic calibration (ECal) module
85093C	Electronic calibration (ECal) module

Definitions

Specification (spec.):

Warranted performance. All specifications apply at 23 °C (± 5 °C), unless otherwise stated, and 90 minutes after the instrument has been turned on. Specifications include guard bands to account for the expected statistical performance distribution, measurement uncertainties, and changes in performance due to environmental conditions.

Typical (typ.):

Describes performance that will be met by a minimum of 80% of all products. It is not guaranteed by the product warranty.

Supplemental performance data (SPD):

Supplemental performance data represents the value of a parameter that is most likely to occur; the expected mean or average. It is not guaranteed by the product warranty.

General characteristics:

A general, descriptive term that does not imply a level of performance.

Boundary Conditions

In this data sheet, boundary conditions are given for the specifications. For example, system dynamic range is 98 dB with the following boundary conditions.

Frequency: 10 MHz, IF bandwidth: 3 kHz

If the same boundary conditions fall under more than one category in a table, apply the best value.

Corrected System Performance

The specifications in this section apply to measurements made with the Agilent E5072A network analyzer under the following conditions:

- No averaging applied to data
- Environmental temperature of 23 °C (± 5 °C) with less than 1 °C deviation from the calibration temperature
- Response and isolation calibration performed

Description	Specification	SPD
System dynamic range at test port ^{1, 2}		
(IF Bandwidth = 3 kHz)		
30 to 300 kHz	65 dB (Typ.)	
300 kHz to 10 MHz	82 dB	
10 MHz to 6 GHz	98 dB	
6 to 8.5 GHz	92 dB	
(IF Bandwidth = 10 Hz)		
30 to 300 kHz	90 dB (Typ.)	100 dB
300 kHz to 10 MHz	107 dB	115 dB
10 MHz to 6 GHz	123 dB	130 dB
6 to 8.5 GHz	117 dB	128 dB
Extended dynamic range at direct receiver access input ³		
(IF Bandwidth = 10 Hz)		
30 to 300 kHz		128 dB
300 kHz to 10 MHz		134 dB
10 MHz to 3 GHz		151 dB
3 GHz to 6 GHz		147 dB
6 to 8.5 GHz		145 dB

1. The test port dynamic range is calculated as the difference between the test port rms noise floor and the source maximum output power. The effective dynamic range must take measurement uncertainty and interfering signals into account.

2. Typical performance might not be met from 60 to 70 kHz.

3. The direct receiver access input system dynamic range is calculated as the difference between the direct receiver access input noise floor and the source maximum output power. The effective dynamic range must take measurement uncertainties and interfering signals into account.

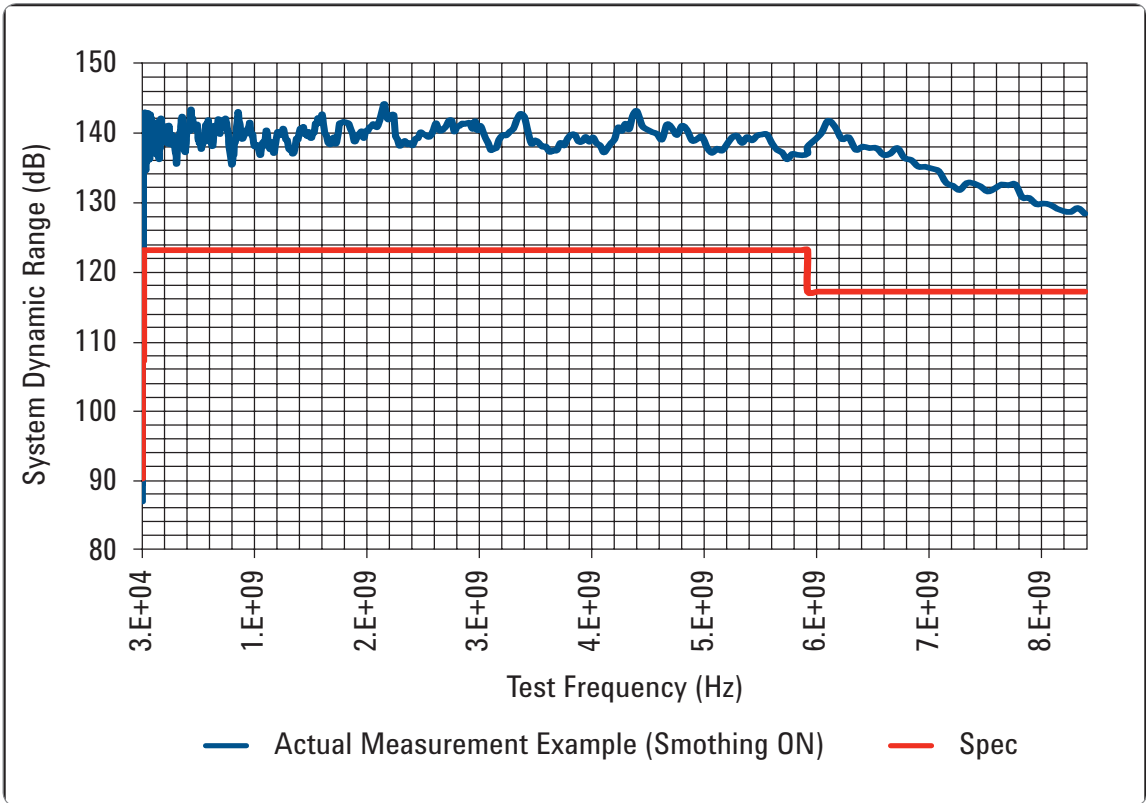

Figure1. System dynamic range (specification and actual measurement data example, IF bandwidth 10 Hz)

Corrected system performance with calibration kit

Corrected system performance with type-N device connectors, 85032F calibration kit

Network analyzer : E5072A
Calibration kit : 85032F (Type-N, 50 Ω)
Calibration : full 2-port

IF bandwidth = 10 Hz, no averaging applied to data, environmental temperature = 23 $^{\circ}\text{C}$ (± 5 $^{\circ}\text{C}$) with < 1 $^{\circ}\text{C}$ deviation from calibration temperature, isolation calibration performed.

Description	Specification (dB)				
	30 to 300 kHz (Typ.)	300 kHz to 10 MHz	10 MHz to 3 GHz	3 to 6 GHz	6 to 8.5 GHz
Directivity	49	49	46	40	38
Source match	41	41	40	36	35
Load match	49	49	46	39	37
Reflection tracking	± 0.011	± 0.011	± 0.021	± 0.032	± 0.054
Transmission tracking	± 0.011	± 0.007	± 0.029	± 0.074	± 0.088

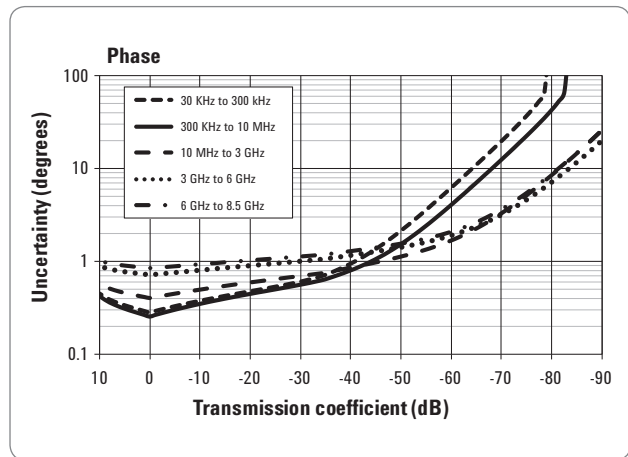
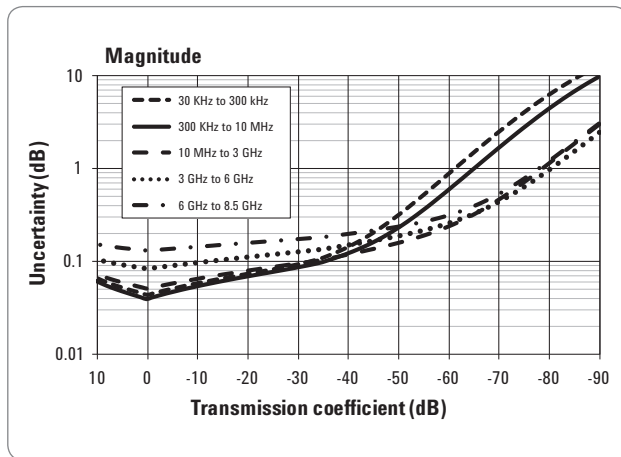

Figure 2. Transmission uncertainty (Specification)

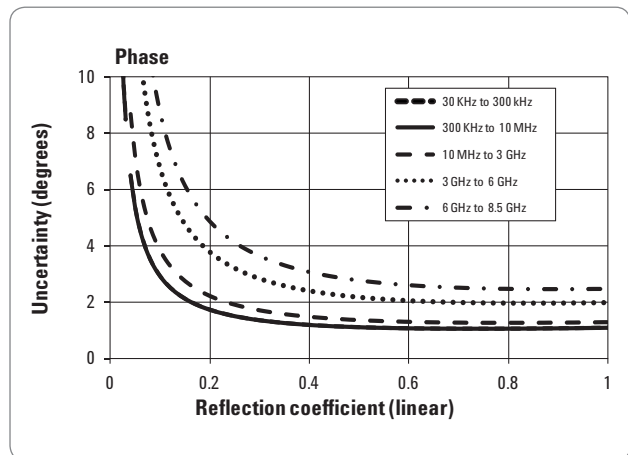
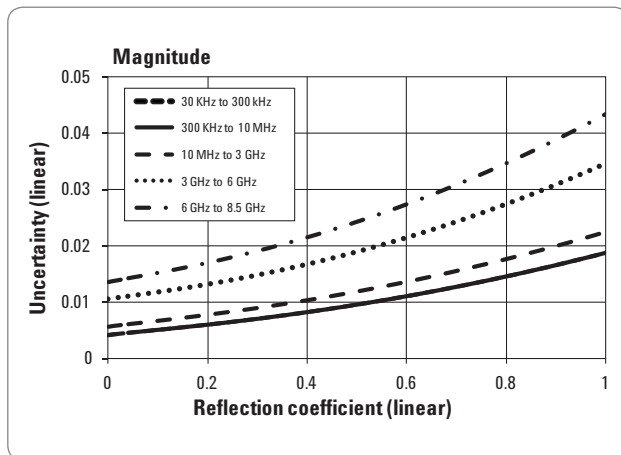

Figure 3. Reflection uncertainty (Specification)

Corrected system performance with type-N device connectors, 85092C electronic calibration (ECal) module

Network analyzer : E5072A
 Calibration kit : 85092C (Type-N, 50 Ω) Electronic calibration (ECal) module
 Calibration : full 2-port

IF bandwidth = 10 Hz, no averaging applied to data, environmental temperature = 23 °C (± 5 °C) with < 1 °C deviation from calibration temperature, isolation calibration is not performed.

Description	Specification (dB)			
	300 kHz to 10 MHz	10 MHz to 3 GHz	3 to 6 GHz	6 to 8.5 GHz
Directivity	45	54	52	47
Source match	36	44	41	36
Load match	41	47	44	39
Reflection tracking	± 0.100	± 0.040	± 0.060	± 0.070
Transmission tracking	± 0.053	± 0.040	± 0.069	± 0.136

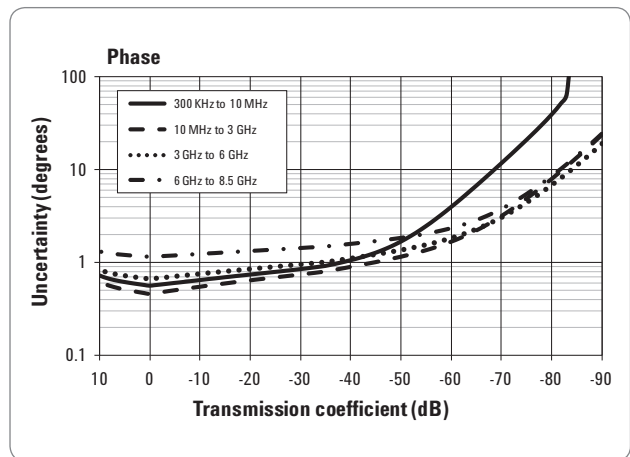
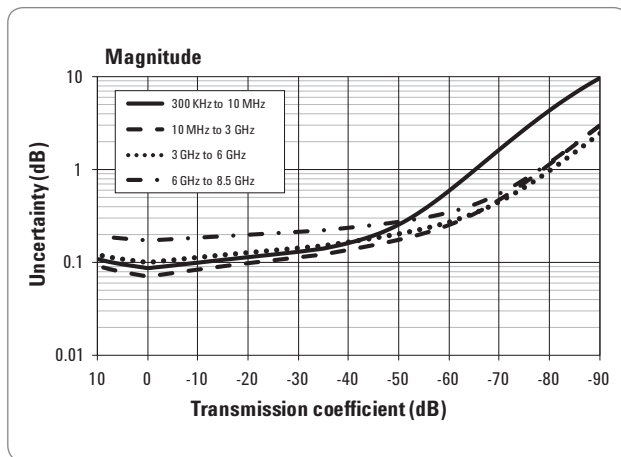

Figure 4. Transmission uncertainty (Specification)

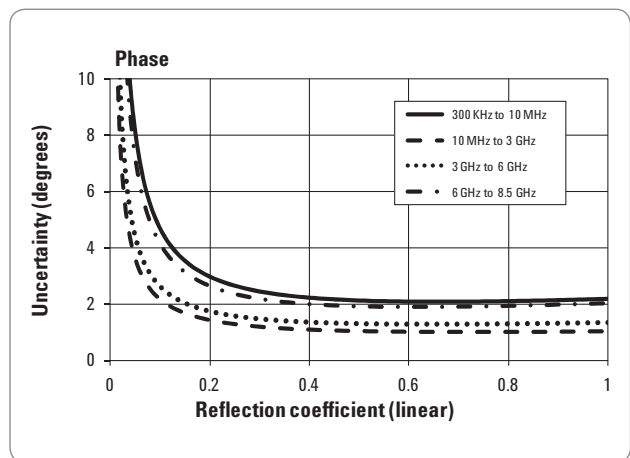
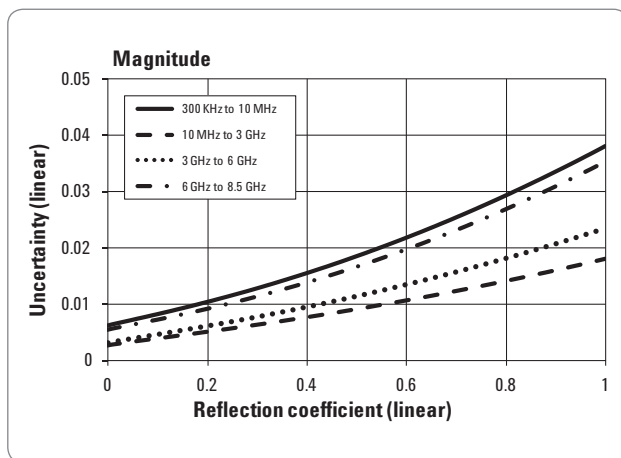

Figure 5. Reflection uncertainty (Specification)

Corrected system performance with 3.5 mm device connector type, 85033E calibration kit

Network analyzer : E5072A
Calibration kit : 85033E (3.5 mm, 50 Ω)
Calibration : full 2-port

IF bandwidth = 10 Hz, no averaging applied to data, environmental temperature = 23 °C (± 5 °C) with < 1 °C deviation from calibration temperature, isolation calibration performed.

Description	Specification (dB)				
	30 to 300 kHz (Typ.)	300 kHz to 10 MHz	10 MHz to 3 GHz	3 to 6 GHz	6 to 8.5 GHz
Directivity	46	46	44	38	38
Source match	43	43	40	37	36
Load match	46	46	44	38	38
Reflection tracking	± 0.006	± 0.006	± 0.007	± 0.009	± 0.010
Transmission tracking	± 0.010	± 0.007	± 0.032	± 0.074	± 0.079

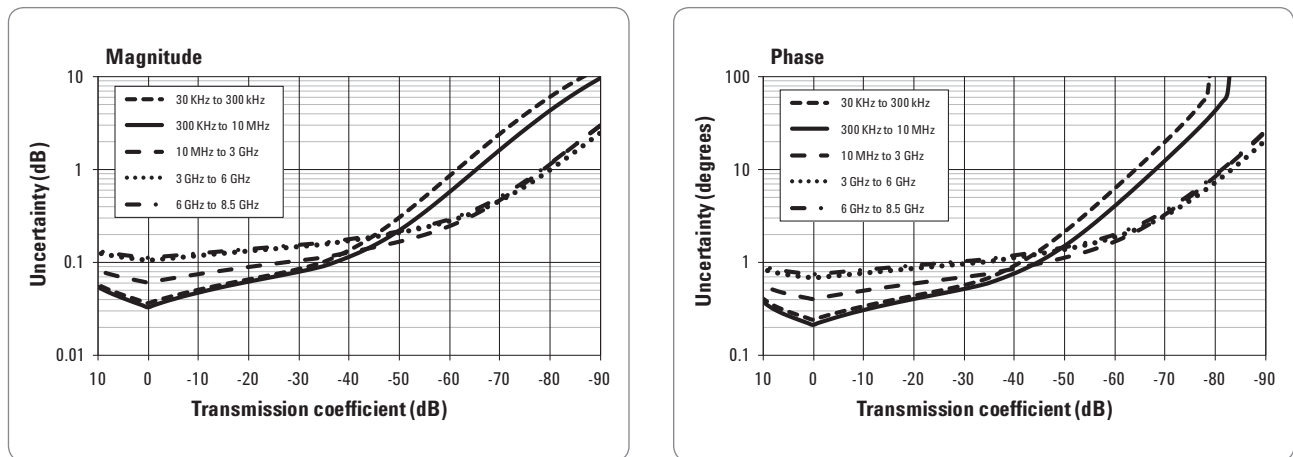

Figure 6. Transmission uncertainty (Specification)

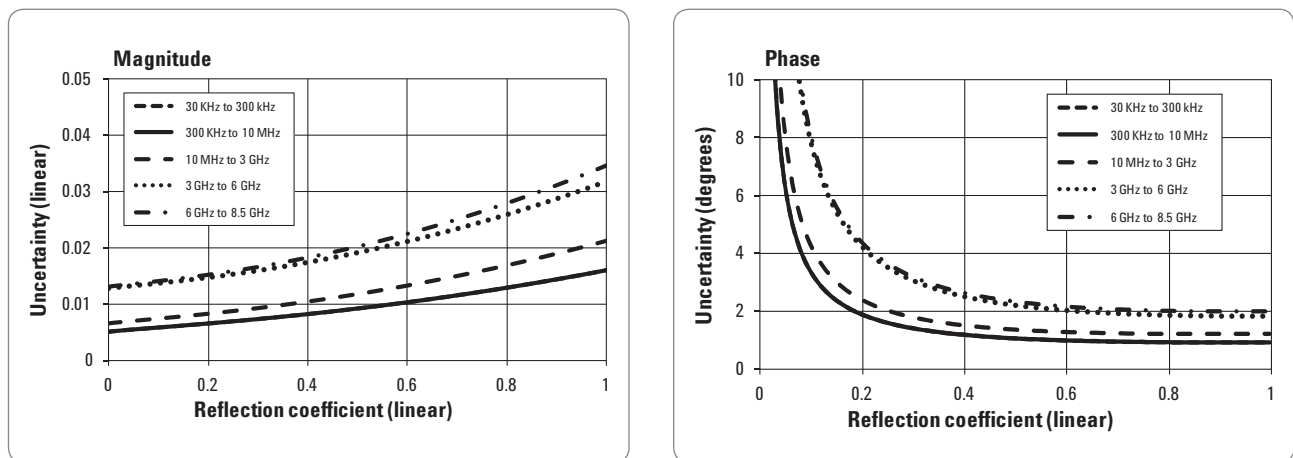

Figure 7. Reflection uncertainty (Specification)

Corrected system performance with 3.5 mm device connector type, 85093C electronic calibration (ECal) module

Network analyzer : E5072A
Calibration kit : 85093C (3.5 mm, 50 Ω) Electronic calibration (ECal) module
Calibration : full 2-port

IF bandwidth = 10 Hz, no averaging applied to data, environmental temperature = 23 °C (± 5 °C) with < 1 °C deviation from calibration temperature, isolation calibration is not performed.

Description	Specification (dB)			
	300 kHz to 10 MHz	10 MHz to 3 GHz	3 to 6 GHz	6 to 8.5 GHz
Directivity	45	52	50	47
Source match	36	44	39	34
Load match	37	45	42	39
Reflection tracking	± 0.100	± 0.040	± 0.050	± 0.070
Transmission tracking	± 0.084	± 0.047	± 0.097	± 0.145

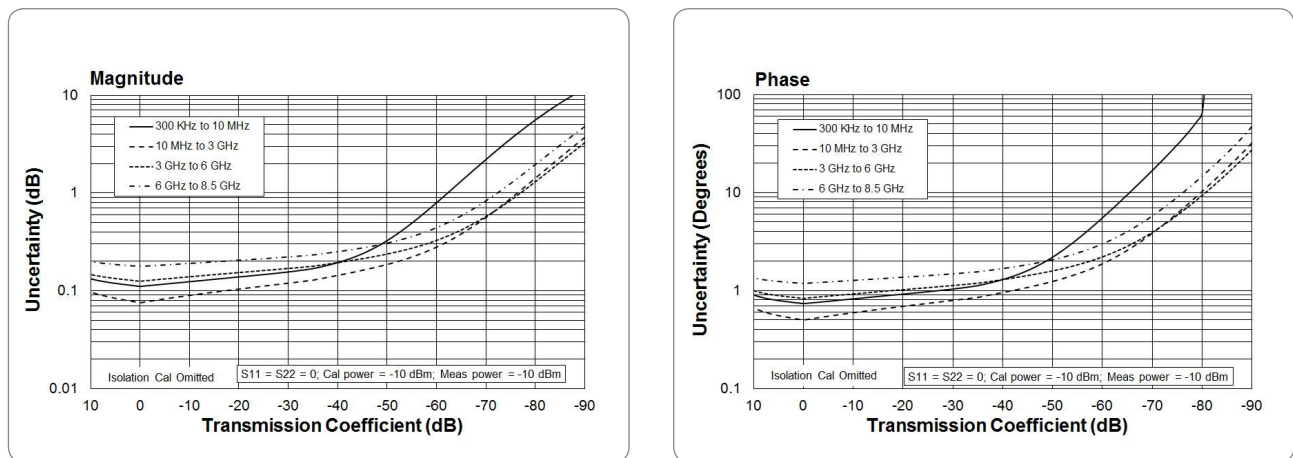

Figure 8. Transmission uncertainty (Specification)

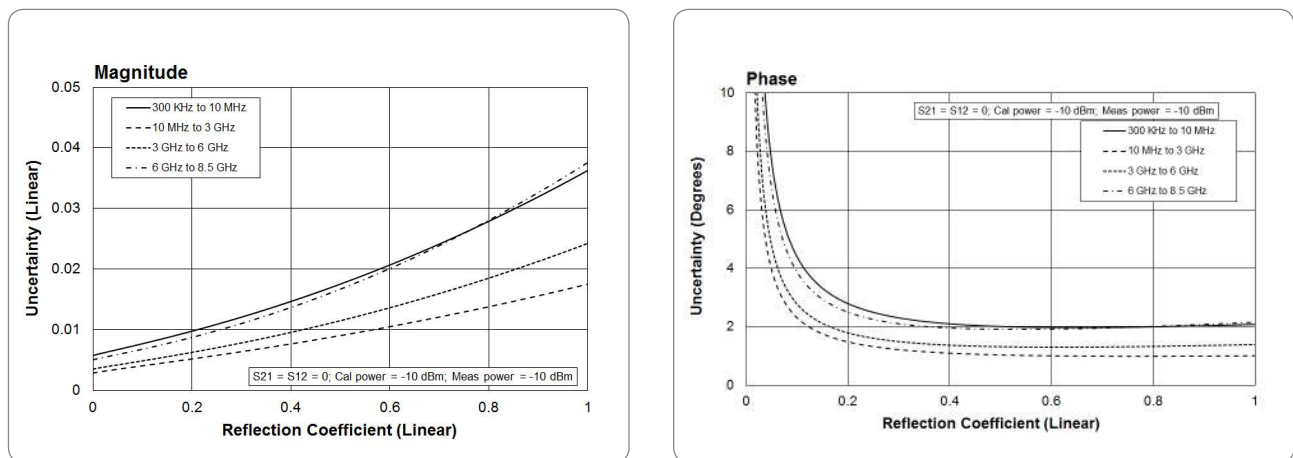

Figure 9. Reflection uncertainty (Specification)

Uncorrected System Performance

User correction: OFF, System error correction: ON

Description	Specification (dB)			
	30 to 300 kHz	300 kHz to 3 GHz	3 to 6 GHz	6 to 8.5 GHz
Directivity	15 (Typ.)	25	20	15
Source match	15 (Typ.)	25	20	15
Reflection tracking	± 1.5 (Typ.)	± 1.0	± 1.5	± 1.5
Transmission tracking	± 1.5 (Typ.)	± 1.0	± 1.5	± 1.5

Description	Specification (dB)				
	30 to 300 kHz	300 kHz to 100 MHz	100 MHz to 2 GHz	2 to 4.5 GHz	4.5 to 8.5 GHz
Load match	14 (Typ.)	22	15	11	8

Test Port Output (Source)

Test port output frequency

Description	Specification	Typical
Frequency range ¹		
Option 245	30 kHz to 4.5 GHz	
Option 285	30 kHz to 8.5 GHz	
Resolution	1 Hz	
Source Stability		
Standard		± 7 ppm (5 to 40 °C)
Option 1E5		± 1 ppm (5 to 40 °C) ± 0.5 ppm/year
CW accuracy		
Standard	± 7 ppm	
Option 1E5	± 1 ppm	

Test port output power²

Description	Specification	SPD
Nominal Power (Preset Power)	0 dBm	
Range ³		
30 to 300 kHz	-85 to 10 dBm	
300 kHz to 3 GHz	-85 to 16 dBm	
3 to 6 GHz	-85 to 12 dBm	
6 to 8.5 GHz	-85 to 10 dBm	
Max Levelled Power		
30 to 300 kHz		16 dBm
300 kHz to 1 GHz		20 dBm
1 to 3 GHz		18 dBm
3 to 8.5 GHz		Slope from 18 dBm (3 GHz) to 12 dBm (8.5 GHz)

1. Frequency can be set down to 9 kHz

2. Source output performance on port 1 only. Port 2 output performance is typical.

3. Power can be set from -109 to 20 dBm

Description	Specification	Typical
Resolution	0.05 dB	
Level Accuracy¹ At 50 MHz, 0 dBm, Absolute	± 0.65 dB	
(Level Flatness) ²		
Stepped Sweep Mode		
30 to 300 kHz	—	± 1.0 dB
300 kHz to 8.5 GHz	± 1.0 dB	—
Swept Sweep Mode		
30 kHz to 7 GHz		± 2.5 dB
7 to 8.5 GHz		± 3.0 dB
Level Linearity³ (–15 dBm to Maximum Power)		
Stepped Sweep Mode		
30 to 300 kHz	—	± 0.75 dB
300 kHz to 8.5 GHz	± 0.75 dB	—
Swept Sweep Mode		
All frequency		± 1.5 dB
Power Sweep Range⁴	65 dB	

Test port output signal purity

Description	Specification	Typical
Harmonics (2nd or 3rd) (at 5 dBm)		
30 kHz to 2 GHz		< –25 dBc
2 to 8.5 GHz		< –20 dBc
Non-harmonic spurious (at 5 dBm)		< –30 dBc

1. Power calibration using an external power meter improves level accuracy of the test port output power.
2. Level accuracy of other frequency is taken at 0 dBm, relative to 50 MHz reference unless otherwise stated.
3. Level linearity given is relative to 0 dBm.
4. Stop power may be limited by maximum power.

Test Port Input

Description	Specification	SPD
Crosstalk¹		
30 to 300 kHz	-90 dB (Typ.)	-95 dB
300 kHz to 10 MHz	-110 dB	-120 dB
10 MHz to 3 GHz	-120 dB	-140 dB
3 to 6 GHz	-110 dB	-130 dB
6 to 8.5 GHz	-100 dB	-120 dB
Test Port Noise Floor¹		
30 to 300 kHz	-90 dBm/Hz (Typ.)	-100 dBm/Hz
300 kHz to 10 MHz	-101 dBm/Hz	-109 dBm/Hz
10 MHz to 3 GHz	-117 dBm/Hz	-124 dBm/Hz
3 to 6 GHz	-121 dBm/Hz	-128 dBm/Hz
6 to 8.5 GHz	-117 dBm/Hz	-128 dBm/Hz
(at 10Hz IFBW)		
30 to 300 kHz	-80 dBm (Typ.)	-90 dBm
300 kHz to 10 MHz	-91 dBm	-99 dBm
10 MHz to 3 GHz	-107 dBm	-114 dBm
3 to 6 GHz	-111 dBm	-118 dBm
6 to 8.5 GHz	-107 dBm	-118 dBm
Compression level (at +10dBm input)		
Magnitude		
30 to 300 kHz	0.3 dB (Typ.)	0.15 dB
300 kHz to 3 GHz	0.2 dB	0.08 dB
3 to 8.5 GHz	0.2 dB	0.1 dB
Phase		
30 to 300 kHz	7 deg (Typ.)	0.7 deg
300 kHz to 3 GHz	5 deg	0.3 deg
3 to 6 GHz	5 deg	0.6 deg
6 to 8.5 GHz	5 deg	1.0 deg
0.1 dB Compression Input Level		
30 to 300 kHz		6 dBm
300 kHz to 2 GHz		16 dBm
2 to 6 GHz		14 dBm
6 to 8.5 GHz		10 dBm
Damage Level		+26 dBm or ± 35 VDC

Trace Noise²

Description	Specification	SPD
(test port input level = maximum power in Specification)		
Magnitude		
30 to 300 kHz, 3 kHz IFBW	0.015 dB rms (Typ.)	0.007 dB rms
300 kHz to 10 MHz, 3 kHz IFBW	0.003 dB rms	0.0005 dB rms
10 MHz to 4.38 GHz, 70 kHz IFBW	0.004 dB rms	0.001 dB rms
4.38 to 8.5 GHz, 70 kHz IFBW	0.006 dB rms	0.0012 dB rms
Phase		
30 to 300 kHz, 3 kHz IFBW	0.1 deg rms (Typ.)	0.05 deg rms
300 kHz to 10 MHz, 3 kHz IFBW	0.02 deg rms	0.0025 deg rms
10 MHz to 4.38 GHz, 70 kHz IFBW	0.035 deg rms	0.0075 deg rms
4.38 to 8.5 GHz, 70 kHz IFBW	0.05 deg rms	0.015 deg rms

1. Typical performance might not be met from 60 to 70 kHz.

2. The specification might not be met at the following frequencies: 333.333 kHz, 406.25 kHz, 857.143 kHz, and 928.571 kHz.

Stability

Description	Specification	SPD
Magnitude		
30 to 300 kHz		$\pm 0.04 \text{ dB}/^\circ\text{C}$
300 kHz to 3 GHz		$\pm 0.005 \text{ dB}/^\circ\text{C}$
3 to 6 GHz		$\pm 0.03 \text{ dB}/^\circ\text{C}$
6 to 8.5 GHz		$\pm 0.04 \text{ dB}/^\circ\text{C}$
Phase		
30 to 300 kHz		$\pm 0.8 \text{ deg}/^\circ\text{C}$
300 kHz to 3 GHz		$\pm 0.1 \text{ deg}/^\circ\text{C}$
3 to 6 GHz		$\pm 0.4 \text{ deg}/^\circ\text{C}$
6 to 8.5 GHz		$\pm 0.8 \text{ deg}/^\circ\text{C}$

Dynamic Accuracy¹

Description	Specification (dB)	Typical
Magnitude		
10 dBm	$\pm 0.21 \text{ dB}$	
-30 dBm	$\pm 0.045 \text{ dB}$	
-100 dBm	$\pm 2 \text{ dB}$	
-110 dBm		$\pm 3.0 \text{ dB}$
Phase		
10 dBm	$\pm 5 \text{ deg}$	
-30 dBm	$\pm 0.3 \text{ deg}$	
-100 dBm	$\pm 15 \text{ deg}$	

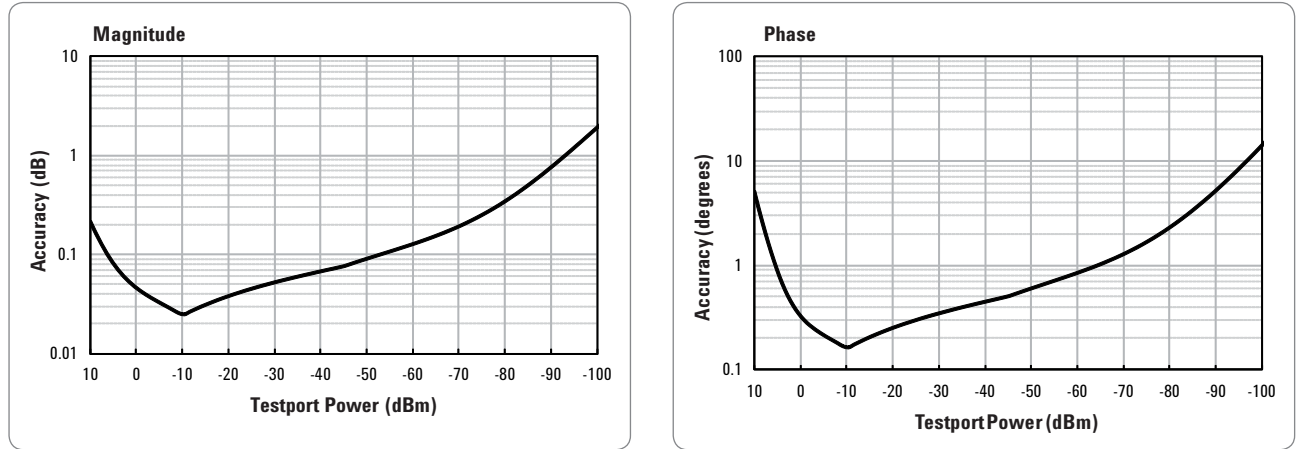

Figure 10. Dynamic Accuracy

1. Accuracy of the test port input power reading is relative to -10 dBm reference input power level.

Group Delay ¹

Description	Specification (dB)	Supplemental information
Aperture (selectable)	(frequency span)/(number of points - 1)	
Maximum aperture	25% of frequency span	
Minimum delay		Limited to measuring no more than 180° of phase change within the minimum aperture.
Accuracy		See graph below (Typical)

The following graph shows group delay accuracy with type-N connectors, full 2-port calibration and a 10 Hz IF bandwidth.

- Calibration kit (85032F).
- Insertion loss is assumed to be < 2 dB.

In general, the following formula can be used to determine the accuracy (in seconds) of a specific group delay measurement:
 $\pm \text{phase accuracy (degrees)} / [360 \times \text{aperture (Hz)}]$

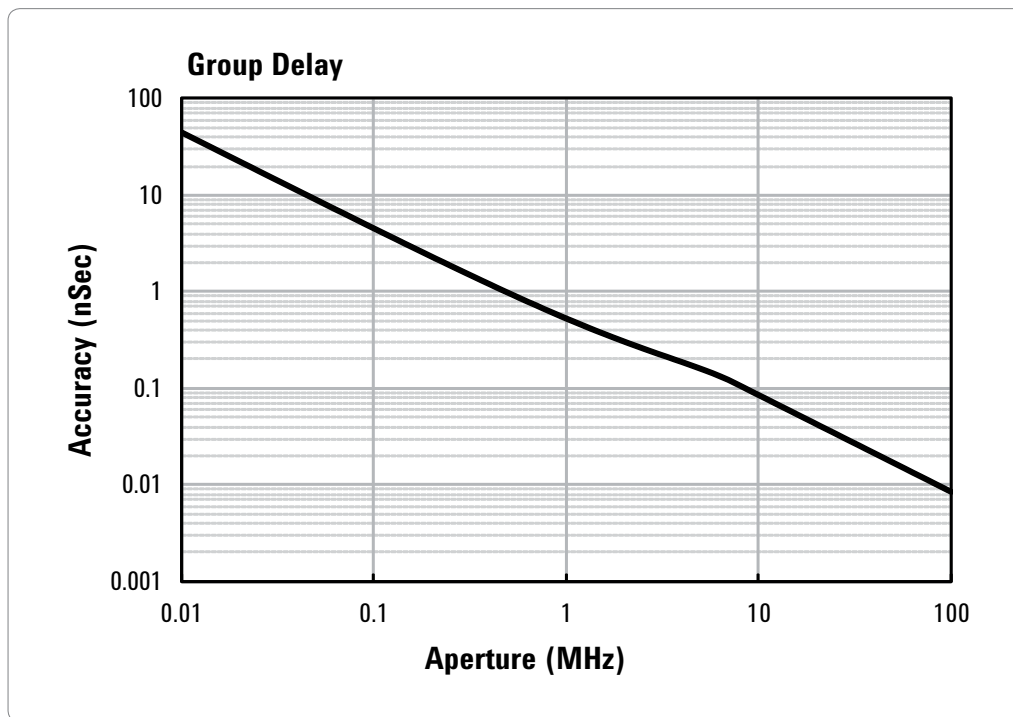

Figure 11. Group delay

1. Group delay is computed by measuring the phase change within a specified step (determined by the frequency span and the number of points per sweep).

Front-Panel Jumpers

Measurement Receiver Input (R1, R2, A, B)

Description	SPD	Typical
Noise Floor		
30 kHz to 10 MHz	-128 dBm/Hz	
10 MHz to 8.5 GHz	-145 dBm/Hz	
(10Hz IFBW)		
30 kHz to 10 MHz	-118 dBm	
10 MHz to 8.5 GHz	-135 dBm	
Maximum Input Level (Rcvr R1/R2/A or B IN at 0.1dB typical compression)		
30 to 300 kHz	-15 dBm	
300 kHz to 8.5 GHz	-10 dBm	
Damage Level		+15 dBm or ± 16 VDC

Coupler arm output

Description	SPD	Typical
Damage Level		+15 dBm or 0 VDC

Coupler through input

Description	SPD	Typical
Insertion Loss from Coupler Thru to Test Port	Slope from 0.8 dB at 30 kHz to 3.5 dB at 8.5 GHz (0.32 x f [GHz] + 0.8) dB	
Damage Level		+26 dBm or ± 35VDC

Source output

Description	SPD	Typical
Maximum Leveled Power		
30 to 300 kHz	+18 dBm	
300 kHz to 1 GHz	+20.5 dBm	
1 to 3 GHz	+19 dBm	
3 to 8.5 GHz	Slope from +19dBm at 3 GHz to +16 dBm at 8.5 GHz	
Maximum Input Level (at Max Specified Output Power)		
30 kHz to 8.5 GHz	+20 dBm	
Damage Level		+26 dBm or 0 VDC

Reference source output

Description	SPD	Typical
Damage Level		+15 dBm or 0 VDC

General Information

Measurement Receiver Input (R1, R2, A, B)

Description	General characteristic
System band width	
Range	10 Hz to 500 kHz Nominal settings are: 10, 15, 20, 30, 40, 50, 70, 100, 150, 200, 300, 400, 500, 700, 1 k, 1.5 k, 2 k, 3 k, 4 k, 5 k, 7 k, 10 k, 15 k, 20 k, 30 k, 40 k, 50 k, 70 k, 100 k, 150 k, 200 k, 300 k, 400 k, 500 kHz

Front Panel

Description	Typical	General characteristic
Test Ports		Type –N, female, 50 Ω (nominal)
Front Panel Jumpers		SMA, female, 50 Ω (nominal)
Probe Power		3 terminal connector x 2
Connector		
Voltage & Maximum current ¹	+15 V ± 5% (400 mA) –12.6 V ± 5% (300 mA)	
Display		
Type		10.4 inch TFT color LCD with touch screen
Resolution		XGA (1024 x 768) ²
USB host port		Universal serial bus jack, Type A configuration; female; provides connection to mouse, keyboard, printer, ECal module, USB power sensor, or USB/GPIB interface

Rear Panel

Description	Typical	General characteristic
External trigger input connector		
Type		BNC, female
Input level		Low threshold voltage: 0.5 V High threshold voltage: 2.1 V Input level range: 0 to +5 V
Pulse width		≥ 2 μsec
Polarity		Positive or negative
External trigger output connector		
Type		BNC, female
Maximum output current		50 mA
Output level		Low level voltage: 0 V High level voltage: 5 V
Pulse width		1 μsec
Polarity		Positive or negative
External reference signal input connector		
Type		BNC, female
Input frequency	10 MHz ± 10 ppm	
Input level	–3 to +10 dBm	

1. Combined load for both probe connections

2. Valid pixels are 99.99% and more. Below 0.01% (approx. 30 points) of fixed points of black, blue, green or red are not regarded as failure.

Rear Panel

Description	Typical	General characteristic
Internal reference signal output connector		
Type		BNC, female
Output frequency	10 MHz \pm 7 ppm	
Signal Type	Sinewave	
Output level	0 dBm \pm 3 dB into 50 Ω	
Output Impedance		50 Ω
Internal reference signal oven connector (Option 1E5)		
Type		BNC, female
Output frequency	10 MHz \pm 1 ppm	
Output level	0 dBm minimum	
Bias tee input connector		
Type		BNC, female
Damage level	\pm 35 V, 1A DC	
No RF spec degradation level	300 mA	
Over current protection	1A (Circuit Breaker)	
Video output		15-pin mini D-Sub; female; drives XGA compatible monitors
GPIB		24-pin D-Sub (Type D-24), female; compatible with IEEE-488
USB host port		Universal serial bus jack, Type A configuration; female; provides connection to mouse, key board, printer, ECal module, USB power sensor, or USB/GPIB interface
USB (USBTMC¹) interface port		Universal serial bus jack, Type B configuration (4 contacts inline); female; provides connection to an external PC; compatible with USBTMC-USB488 and USB 2.0.LA
LAN		10/100BaseT Ethernet, 8-pin configuration; auto selects between the two data rates
Handler I/O port		36-pin centronics, female; provides connection to handler system
Line Power²		
Frequency		47 Hz to 63 Hz
Voltage		90-264 VAC (V _{peak} \geq 120V)
VA max		350 VA max.
Power consumption		135 W (SPD)

Rear panel

Description	Specification	General characteristic
AUX input connector		
Type		BNC, female
Input Range	1% + 1 mV for \pm 1 V input	\pm 1 V or \pm 10 V selectable
Accuracy	1% + 10 mV for \pm 10 V input	

1. USB Test and Measurement Class (TMC) interface that communicates over USB, complying with the IEEE 488.1 and IEEE 488.2 standards.
2. A third-wire ground is required.

Block Diagram

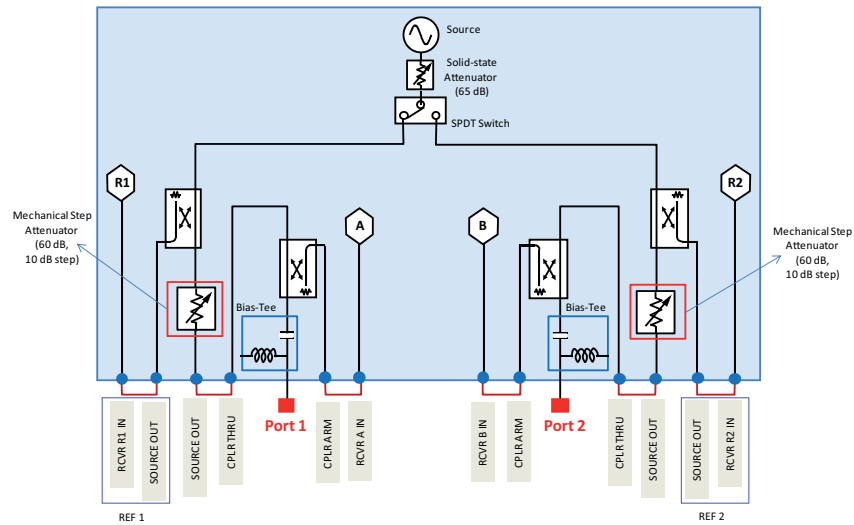

EMC, safety, environment and compliance

Description

Specification

EMC



European Council Directive 2004/108/EC
 IEC 61326-1:2005
 EN 61326-1:2006
 CISPR 11:2003+A1:2004
 EN 55011:2007
 Group 1, Class A
 IEC 61000-4-2:1995 +A2:2000
 EN 61000-4-2:1995 +A2:2001
 4 kV CD/8 kV AD
 IEC 61000-4-3:2006
 EN 61000-4-3:2006
 1-3 V/m, 80-1000 MHz/1.4 GHz - 2.7 GHz, 80% AM
 IEC 61000-4-4:2004
 EN 61000-4-4:2004
 1 kV power lines/0.5 kV signal lines
 IEC 61000-4-5:2005
 EN 61000-4-5:2006
 0.5 kV line-line/1 kV line-ground
 IEC 61000-4-6:2003 + A1:2004+ A2:2006
 EN 61000-4-6:2007
 3 V, 0.15-80 MHz, 80% AM
 IEC 61000-4-11:2004
 EN 61000-4-11:2004
 0.5-300 cycle, 0%/70%





ICES/NMB-001

ICES-001:2006 Group 1, Class A



AS/NZS CISPR11:2004 Group 1, Class A

EMC, safety, environment and compliance

Description	Specification
Safety	
 ISM 1-A	European Council Directive 2006/95/EC IEC 61010-1:2001/EN 61010-1:2001 Measurement Category I Pollution Degree 2 Indoor Use
 C US	CAN/CSA C22.2 No. 61010-1-04 Measurement Category I Pollution Degree 2 Indoor Use
Environment	
	<p>This product complies with the WEEE Directive (2002/96/EC) marking requirements. The affixed label indicates that you must not discard this electrical/electronic product in domestic household waste.</p> <p>Product Category: With reference to the equipment types in the WEEE Directive Annex I, this product is classed as a “Monitoring and Control instrumentation” product.</p> <p>Do not dispose in domestic household waste. To return unwanted products, contact your local Agilent office, or see http://www.agilent.com/environment/product/ for more information.</p>
Compliance	
	Class C

Analyzer environmental specifications and dimensions

Description	General characteristics
Operating environment	
Temperature	+5 °C to +40 °C
Error-corrected temperature range	23 °C (± 5 °C) with < 1 °C deviation from calibration temperature
Humidity	20% to 80% at wet bulb temperature < +29 °C (non-condensation)
Altitude	0 to 2,000 m (0 to 6561 feet)
Vibration	0.21 G maximum, 5 Hz to 500 Hz
Non-operating environment	
Temperature	-10 °C to +60 °C
Humidity	20% to 90% at wet bulb temperature < +40 °C (non-condensation)
Altitude	0 to 4,572 m (0 to 15,000 feet)
Vibration	0.5 G maximum, 5 Hz to 500 Hz
Dimensions	See next page
Weight (net)	Option 017: 19.8 kg Option 019: 19.0 kg

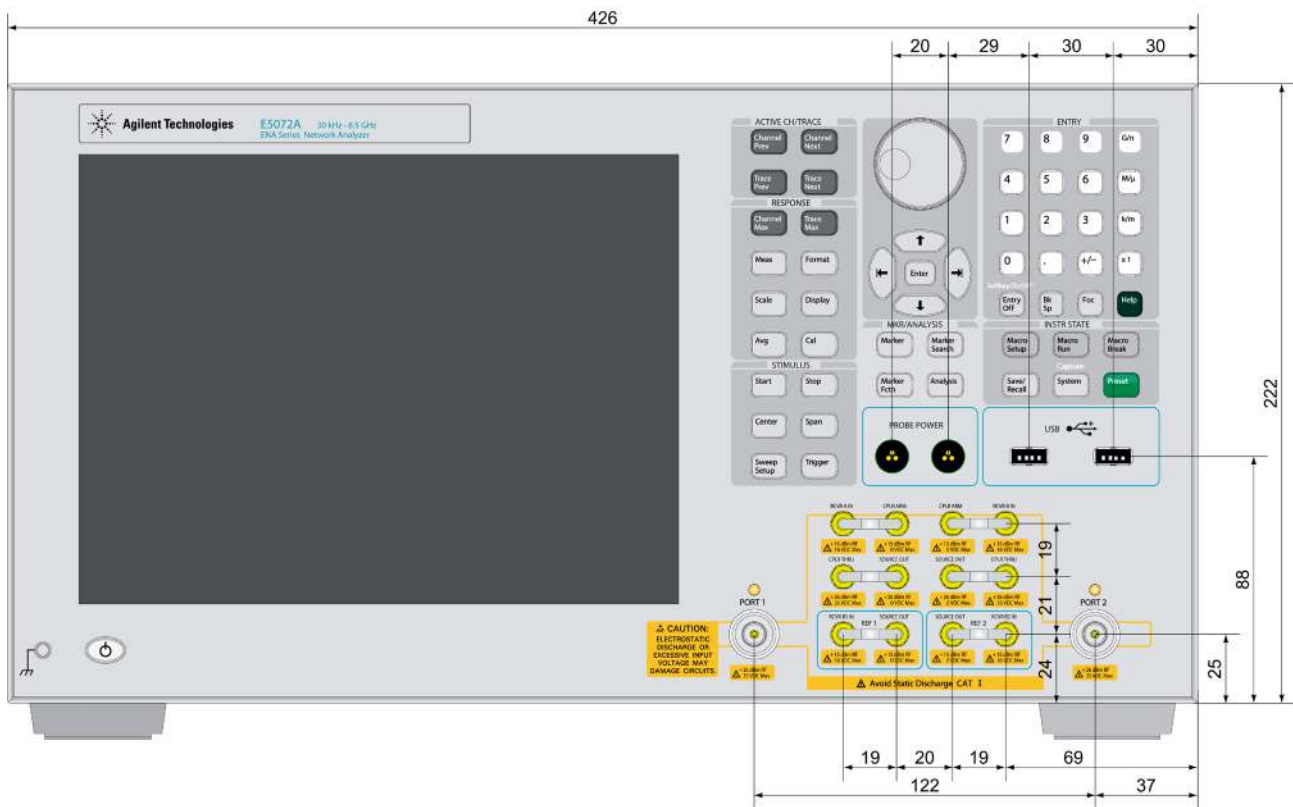

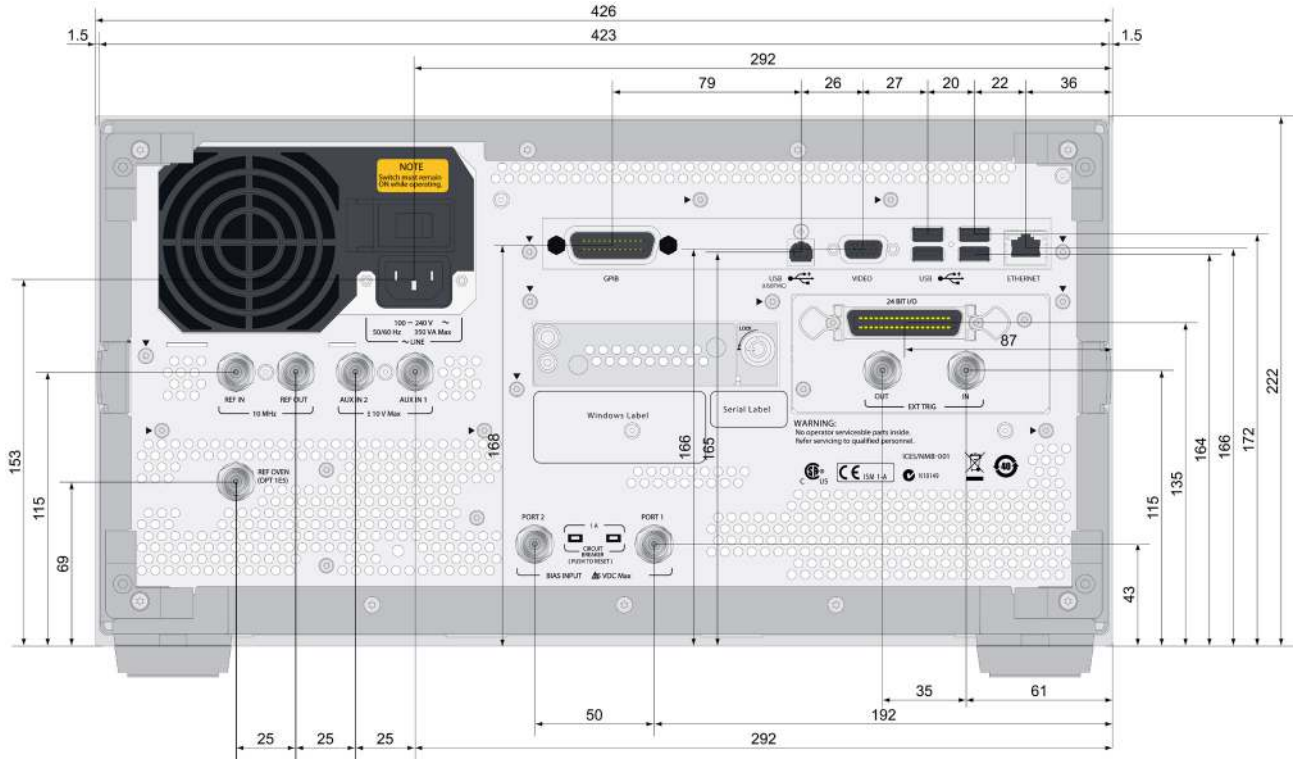

Dimensions (rear view)

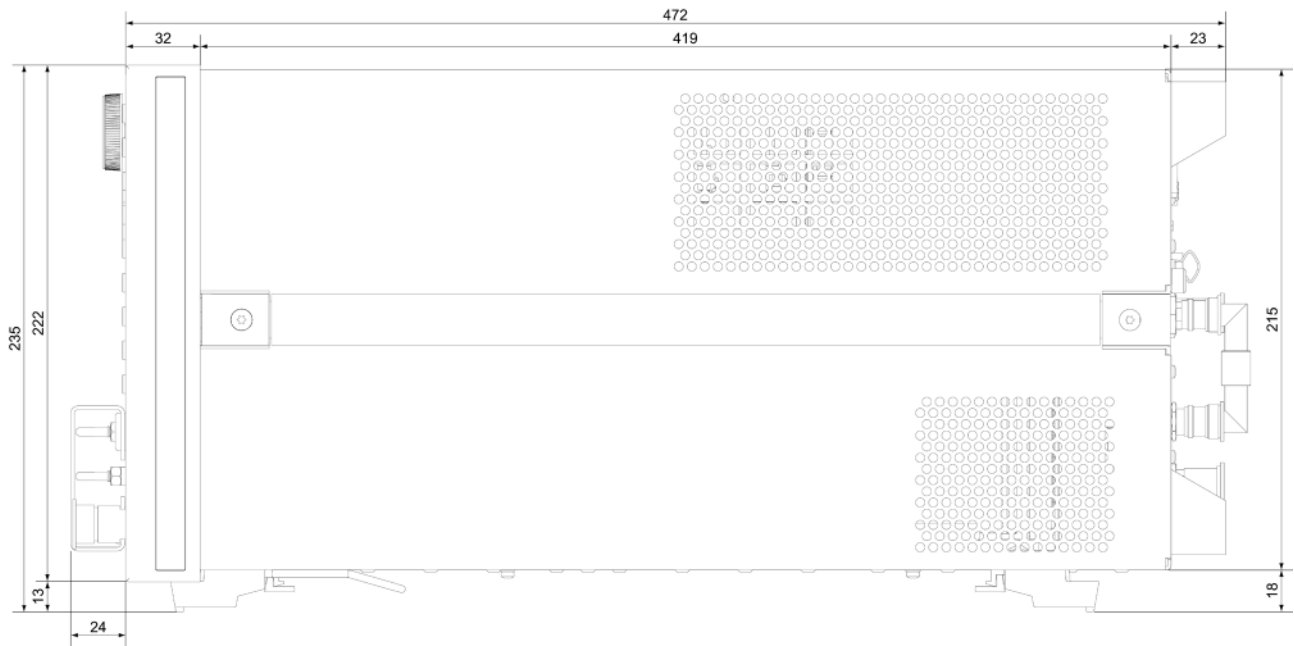

Dimensions (side view)

Measurement Throughput Summary

Measurement throughput data is supplemental performance data. Common condition for the measurement throughput data:

- Analyzer display turned off with: DISP : ENAB OFF
- Number of traces = 1
- firmware version: A.01.00

Cycle time for measurement completion

	Sweep mode: Swept System error correction: OFF				Sweep mode: Step System error correction: ON			
Number of Points	51	201	401	1601	51	201	401	1601
Start 1 GHz, stop 1.2 GHz, 500 kHz IF bandwidth								
Uncorrected	2 ms	3 ms	4 ms	12 ms	3 ms	6 ms	10 ms	26 ms
2-port cal	2 ms	4 ms	7 ms	23 ms	4 ms	11 ms	18 ms	51 ms
Start 1 GHz, stop 1.2 GHz, 1 kHz IF bandwidth								
Uncorrected	52 ms	199 ms	394 ms	1560 ms	52 ms	199 ms	394 ms	1600 ms
2-port cal	102 ms	396 ms	786 ms	3119 ms	102 ms	396 ms	786 ms	3119 ms
Start 30 kHz, stop 4.5 GHz, 500 kHz IF bandwidth								
Uncorrected	9 ms	11 ms	12 ms	18 ms	5 ms	11 ms	16 ms	45 ms
2-port cal	16 ms	21 ms	23 ms	35 ms	10 ms	20 ms	32 ms	90 ms
Start 30 kHz, stop 4.5 GHz, 1 kHz IF bandwidth								
Uncorrected	54 ms	203 ms	401 ms	1579 ms	54 ms	203 ms	401 ms	1579 ms
2-port cal	107 ms	405 ms	800 ms	3158 ms	107 ms	405 ms	800 ms	3157 ms
Start 30 kHz, stop 8.5 GHz, 500 kHz IF bandwidth								
Uncorrected	12 ms	16 ms	17 ms	20 ms	6 ms	11 ms	17 ms	45 ms
2-port cal	24 ms	31 ms	33 ms	38 ms	10 ms	21 ms	32 ms	90 ms
Start 30 kHz, stop 8.5 GHz, 1 kHz IF bandwidth								
Uncorrected	55 ms	204 ms	401 ms	1579 ms	55 ms	204 ms	401 ms	1579 ms
2-port cal	108 ms	406 ms	801 ms	3157 ms	108 ms	406 ms	801 ms	3157 ms

Cycle time vs. number of points

Condition: Start 1 GHz, stop 1.2 GHz, 500 kHz IF bandwidth

Number of Points	Sweep mode: Swept System error correction: OFF	Sweep mode: Step System error correction: ON
3	1 ms	1 ms
11	2 ms	2 ms
51	2 ms	3 ms
101	2 ms	4 ms
201	3 ms	6 ms
801	7 ms	16 ms
1601	12 ms	27 ms

Cycle time vs. IF bandwidth

Condition: NOP=201, system error correction: OFF, Sweep mode: sweep

IF BW (Hz)	Cycle Time (ms)	IF BW (Hz)	Cycle Time (ms)	IF BW (Hz)	Cycle Time (ms)	IF BW (Hz)	Cycle Time (ms)	IF BW (Hz)	Cycle Time (ms)
10	19297	100	1931	1000	195	10000	20	100000	3
15	12865	150	1288	1500	130	15000	14	150000	3
20	9649	200	1091	2000	98	20000	11	200000	3
30	6433	300	645	3000	66	30000	8	300000	3
40	4825	400	484	4000	50	40000	6	400000	2
50	3861	500	388	5000	40	50000	5	500000	2
70	2735	700	276	7000	29	70000	4		

Data transfer time ¹

Number of Points	51	201	401	1601
SCPI over GPIB				
64-bit floating point	5 ms	15 ms	28 ms	110 ms
32-bit floating point	3 ms	8 ms	15 ms	56 ms
ASCII	21 ms	78 ms	156 ms	618 ms
SCPI over 100 Mbps LAN (Socket) ²				
REAL 64	1 ms	1 ms	2 ms	3 ms
REAL 32	1 ms	1 ms	1 ms	2 ms
ASCII	13 ms	47 ms	93 ms	363 ms
SCPI over 100 Mbps LAN (SICL-LAN)				
REAL 64	3 ms	3 ms	4 ms	6 ms
REAL 32	3 ms	3 ms	4 ms	4 ms
ASCII	3 ms	7 ms	11 ms	37 ms
SCPI over USB ²				
REAL 64	2 ms	2 ms	2 ms	3 ms
REAL 32	2 ms	2 ms	2 ms	3 ms
ASCII	3 ms	9 ms	17 ms	66 ms
SCPI over GPIB/USB (82357B)				
REAL 64	8 ms	14 ms	23 ms	77 ms
REAL 32	7 ms	10 ms	14 ms	41 ms
ASCII	74 ms	285 ms	568 ms	2268 ms
COM ³				
Variant Type	1 ms	1 ms	1 ms	1 ms

1. Measured using a VEE Pro 7.0 program running on a 3.2 GHz Pentium 4 DELL Precision 370, Transferred complex S11 data, using : CALC{1-36} : DATA : FDAT?.

2. USB Test and Measurement Class (TMC) interface that communicates over USB, complying with the IEEE 488.1 and IEEE 488.2 standards.

3. Measured using an E5072A VBA macro running inside the analyzer. Transferred complex S11 data



myAgilent

www.agilent.com/find/myagilent

A personalized view into the information most relevant to you.



www.lxistandard.org

LAN eXtensions for Instruments puts the power of Ethernet and the Web inside your test systems. Agilent is a founding member of the LXI consortium.



Three-Year Warranty

www.agilent.com/find/ThreeYearWarranty

Beyond product specification, changing the ownership experience.

Agilent is the only test and measurement company that offers three-year warranty on all instruments, worldwide



www.agilent.com/quality

Agilent Electronic Measurement Group
DEKRA Certified ISO 9001:2008
Quality Management System

Agilent Channel Partners

www.agilent.com/find/channelpartners

Get the best of both worlds: Agilent's measurement expertise and product breadth, combined with channel partner convenience.

For more information on Agilent Technologies' products, applications or services, please contact your local Agilent office. The complete list is available at: www.agilent.com/find/contactus

Americas

Canada	(877) 894 4414
Brazil	(11) 4197 3600
Mexico	01800 5064 800
United States	(800) 829 4444

Asia Pacific

Australia	1 800 629 485
China	800 810 0189
Hong Kong	800 938 693
India	1 800 112 929
Japan	0120 (421) 345
Korea	080 769 0800
Malaysia	1 800 888 848
Singapore	1 800 375 8100
Taiwan	0800 047 866
Other AP Countries	(65) 375 8100

Europe & Middle East

Belgium	32 (0) 2 404 93 40
Denmark	45 45 80 12 15
Finland	358 (0) 10 855 2100
France	0825 010 700* *0.125 €/minute
Germany	49 (0) 7031 464 6333
Ireland	1890 924 204
Israel	972-3-9288-504/544
Italy	39 02 92 60 8484
Netherlands	31 (0) 20 547 2111
Spain	34 (91) 631 3300
Sweden	0200-88 22 55
United Kingdom	44 (0) 118 927 6201

For other unlisted countries:

www.agilent.com/find/contactus

(BP-09-27-13)

Product specifications and descriptions in this document subject to change without notice.

© Agilent Technologies, Inc. 2013 - 2014
Published in USA, February 11, 2014
5990-8002EN

